























PC-SF1 Clip femelle à visser

| PC-SF1 | Utilisé avec: | Outils d'installation : | | | | | | | | | |
|---|---|---|---|---|---|---|--|--|--|---|--------------|
|  | <table border="0"> <tr> <td data-bbox="318 339 389 411">PC-M1B </td> <td data-bbox="396 339 468 411">PC-VM1 </td> <td data-bbox="474 339 546 411">PC-SM2 </td> </tr> <tr> <td data-bbox="318 421 389 491">PC-M2H </td> <td data-bbox="396 421 468 491">PC-VMX </td> <td data-bbox="474 421 605 491">PC-SM2H </td> </tr> <tr> <td></td> <td></td> <td data-bbox="542 421 605 491">PC-SM1AC </td> </tr> </table> | PC-M1B  | PC-VM1  | PC-SM2  | PC-M2H  | PC-VMX  | PC-SM2H  | | | PC-SM1AC  | Vis ou rivet |
| PC-M1B  | PC-VM1  | PC-SM2  | | | | | | | | | |
| PC-M2H  | PC-VMX  | PC-SM2H  | | | | | | | | | |
| | | PC-SM1AC  | | | | | | | | | |

PHASES D'INSTALLATION - OPTIONS

- 1** Fixer par vissage le PC-SF1 sur la structure (vissage en applique).

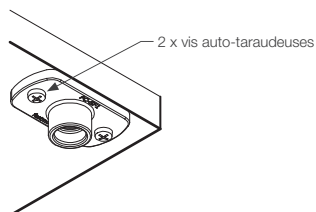



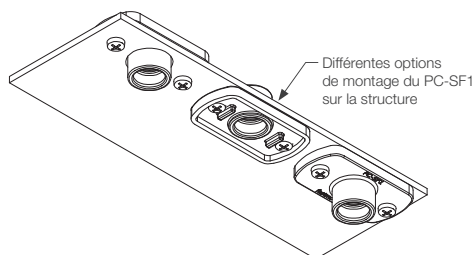



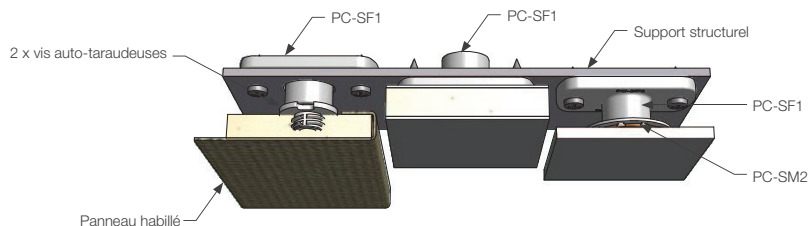























- 2** Différentes options de montage du PC-SF1 sur la structure.



- 3** Options de montage du PC-SF1 sur la structure avec illustration de différents types de panneaux et clips mâles.



PC-SF1 Clip femelle à visser

| PC-SF1 | Utilisé avec: | Outils d'installation : | | | | | | | | | | | |
|---|--|---|---|---|--|---|---|---|---|---|---|---|---|
|  | <table border="0"> <tr> <td data-bbox="318 341 389 411"></td> <td data-bbox="396 341 468 411"></td> <td data-bbox="474 341 546 411"></td> <td></td> </tr> <tr> <td data-bbox="318 421 389 491"></td> <td data-bbox="396 421 468 491"></td> <td data-bbox="474 421 546 491"></td> <td data-bbox="553 421 605 491"></td> </tr> </table> |  |  |  | |  |  |  |  | <table border="0"> <tr> <td data-bbox="680 341 752 443"></td> <td data-bbox="766 341 837 469"></td> <td data-bbox="851 341 922 469"></td> </tr> </table> |  |  |  |
|  |  |  | | | | | | | | | | | |
|  |  |  |  | | | | | | | | | | |
|  |  |  | | | | | | | | | | | |

INSTALLATION DES CLIPS MALES A COLLER

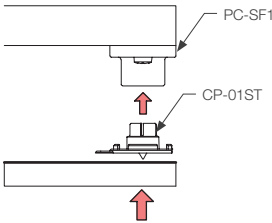
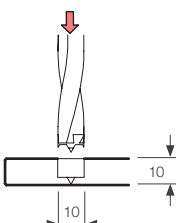
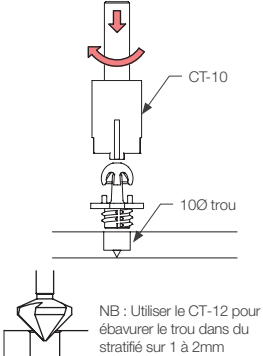
| | | |
|--|--|---|
| <p>1 Mettre en place l'insert de centrage CP-01ST dans le PC-SF1, puis positionner le panneau pour le marquer.</p>  | <p>2 Percer le panneau sur le marquage avec le CT-09 (7.5mm de profondeur).</p>  | <p>3 Visser (auto-tarauder) le clip mâle avec le CT-10 en utilisant le bon couple de serrage de la visseuse.</p>  <p>NB : Utiliser le CT-12 pour ébavurer le trou dans du stratifié sur 1 à 2mm</p> |
|--|--|---|

INSTALLATION DES CLIPS MALES A COLLER (commencer par l'étape 1, page précédente)

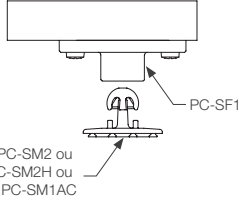
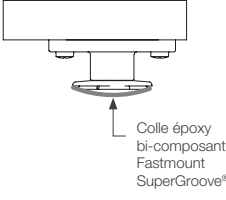
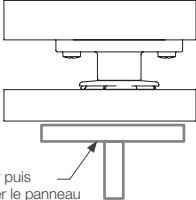
| | | |
|---|---|---|
| <p>4 Installer le PC-SM2 ou PC-SM2H ou PC-SM1AC dans le PC-SF1.</p>  | <p>5 Appliquer l'époxi sur l'embase du PC-SM2, PC-SM2H ou PC-SM1AC.</p>  <p>Colle époxy bi-composant Fastmount SuperGroove®</p> | <p>6 Positionner et maintenir le panneau en place.</p>  <p>Caler puis étayer le panneau</p> |
|---|---|---|